

GEYSERWISE INSTRUCTION MANUAL

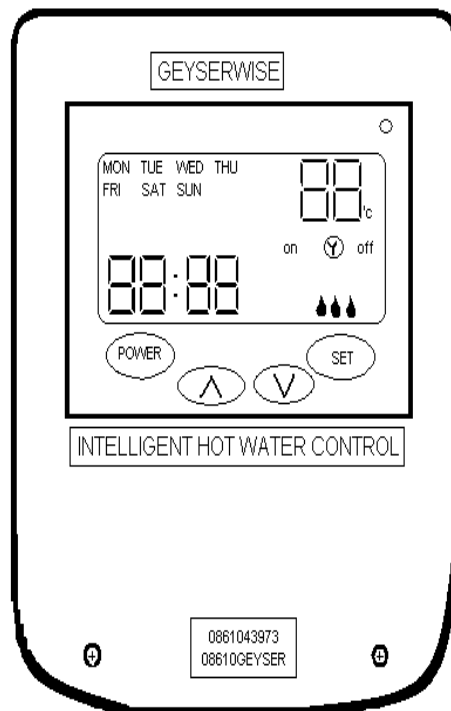

GEYSERWISE MAX
DELTA "T"
ALL IN ONE HOT WATER MANAGEMENT

Before operating and installation, carefully read all instructions.
Do not discard this manual.



INDEX

1. Package Contents	1
2. About this manual	1
2.1 Applicability	1
2.2 Users	1
3. Safety	1
3.1 Proper usage	1
3.2 Improper usage	1
3.3 Dangers during installation	2
3.4 Detecting faults	2
3.5 Exclusion of liability	2
4. Uses, Characteristics and technical information	3
4.1 Uses	3
4.2 Characteristics	3
4.3 Technical information	3
5. Installation	4
5.1 Installation notice	4
5.2 Diagram – power supply	4
5.3 Terminal plan and wiring diagram	5
5.4 Connector plan	5
5.5 12 V battery plan	6
5.6 Installation: geyser and thermosiphon solar system	6
5.7 Installation: split pump system with 220V pump	6
5.8 Installation: split pump system with 12V pump, PV panel and back-up battery	7
6. Operation	7
6.1 Display	7
6.2 Setting the water temperature	7
6.3 Adjusting day of the week	9
6.4 Adjusting the time	9
6.5 Setting timers	9
6.6 Power save mode	11
6.7 Holiday /mode	11
6.8 Bypassing the timers	12
6.9 Check energy usage in hours	12
6.10 Useful tips	12
7. Operation: thermosiphon solar system	12
8. Operation: split pump system	13
9. Error codes	14

9.1	Summary of error codes	14
9.2	E1	14
9.3	E2	14
9.4	E3	15
9.5	E4	15
9.6	E5	15
9.7	E6	15
9.8	E7	15
9.9	E8	16
9.10	E9	16
10.	Sensor R-T table	16
11.	Warranty	17
12.	Supplier details	17

1 PACKAGE CONTENTS

- 1 x Power supply box
- 1 x Display unit
- 1 x Temperature probe with thermal fuse
- 1 x Collector temperature probe
- 1 x Water leak detector
- 2 x Wall plugs and mounting screws
- 1 x 5m Extension cable
- 1 x Instruction manual

ADDITIONAL COMPONENTS AVAILABLE TO PURCHASE SEPARATELY

- Solenoid valve to dump water in overheat situation
- Reference probe for anode indicator
- Additional extension cables

It is not recommended that the display unit is installed more than 20m from the power supply box.

2 ABOUT THIS MANUAL

2.1 Applicability

This manual describes the installation, operation and maintenance for the Geysewise Max Delta T Hot Water Controller for electric geysers and solar hot water geysers. When installing the remaining components eg. Solar collectors, pumps and geysers, be sure to follow the appropriate installation instructions provided by each manufacturer.

2.2 Users

Installation, maintenance and dismantling may only be performed by trained personnel in accordance with this instruction manual and safety instructions. Trained personnel must be familiar with this manual.

Use the Geysewise only after first thoroughly reading and understanding this instruction manual and the safety instructions. In the event of any ambiguities regarding the installation and operation, consult trained personnel or contact our offices.

3 SAFETY

3.1 Proper Usage

The Geysewise may only be used for systems within the permissible ambient conditions

3.2 Improper usage

The Geysewise must not be operated in the following environments:

- Outdoors

- In damp rooms
- In rooms in which the operation of electrical and electronic components may be dangerous

3.3 Dangers during Installation

The following dangers exist during installation of the Geysewise and during operation (in case of incorrect installation)

- Risk of death by electrocution
- Risk of fire due to short circuit
- Damage to any of the constructional fire safety measures present in the building due to incorrectly installed cables
- Damage to the Geysewise and connected devices due to improper ambient conditions, inappropriate power supply and incorrect installation
- Therefore all safety regulations apply when working on the mains supply
- Be sure to comply with the specified degree of protection.
- Factory labels and markings may not be altered, removed or rendered unreadable
- Before connecting the Geysewise, make sure that the power supply matches the specifications on the type plate
- Make sure that all devices which are connected to the Geysewise conform to the technical specifications of the Geysewise
- All work on an open Geysewise must be performed with the mains supply disconnected
- Protect the controller against overloading and short-circuiting

3.4 Detecting Faults

- Check the display regularly
- In case of faults, isolate the cause
- As soon as it becomes evident that safe operation is no longer possible, remove the Geysewise from the mains supply immediately
- Have trained personnel remedy the fault

3.5 Exclusion of liability

The manufacturer cannot monitor the compliance to this manual as well as the conditions and methods during installation and operation. Improper installation of the system may result in damage to the property and, as a result, in bodily injury.

Therefore, we assume no responsibility for loss, damage or costs which result from or are in any way related to incorrect installation, improper operation, incorrect execution of installation work and incorrect usage and maintenance.

The manufacturer reserves the right to make changes to the product, technical data or assembly and operating instructions without prior notice.

4 USES, CHARACTERISTICS AND TECHNICAL INFORMATION

4.1 Uses

Geysewise is designed to manage your hot water needs to your best advantage from both an energy and economical point of view. It uses professional techniques and the control system is managed by computer micro processor.

4.2 Characteristics

- Clear display of water temperature, time, day, heating mode, malfunction conditions.
- Auto or manual heating.
- Easy temperature setting to your requirements (30° C - 65° C) Factory default is 55° C.
- Four different temperature settings
- Daily programmable timer with four time settings. Default settings to coincide with South African municipal load control programs.
- Battery back up in event of power failure.
- Multiple protection functions: Dry heat, heat failure, earth leakage, probe failure overheat, water leak.
- Error conditions alert by error code E1 to E9.

4.3 Technical Parameters

- Operating voltage 230VAC / 50HZ.
- Main Relay contact rating 30AMP (Max 4KW).
- Secondary relays pump and solenoid 5Amp.
- Operating voltage range 160V – 250V AC.
- Earth leakage protection at 25MA action time $\leq 0,1$ second.
- Temperature display range 0 - 99°C ("-5" when below -5°C "OE" when above 99°C).
- Temperature setting ranges 30 - 65°C.
- Maximum temperature 85°C.
- Heat failure – when increase at a rate of less than 4°C per hour.
- Thermal Cutout 90° C
- Dry Heat detection – Empty Cylinder.
- Temperature tolerance $\pm 2\%$
- Temperature differential setting 1°C.
- Switching differential 6°C.
- 2nd temperature probe for solar
- Solar differential 7°C
- Temperature probe failure detection for both collector and tank
- Temperature probe range for geyser is -30 to + 130° C.
- Temperature probe range for collector is -30 to + 260° C
- Isolate both L + N when in off state.
- Collector antifreeze protection

- Anode depletion indicator
- Home alarm interface

5 INSTALLATION

5.1 Installation Notice

- Isolate electrical supply before installation
- Installation should be by a suitably qualified person only
- The grounding (earth) must be continuous
- Install in a dry location
- If a 3 pin 16 Amp plug top is used heating element should not exceed 2.5 Kw

5.2 Diagram - Power Supply

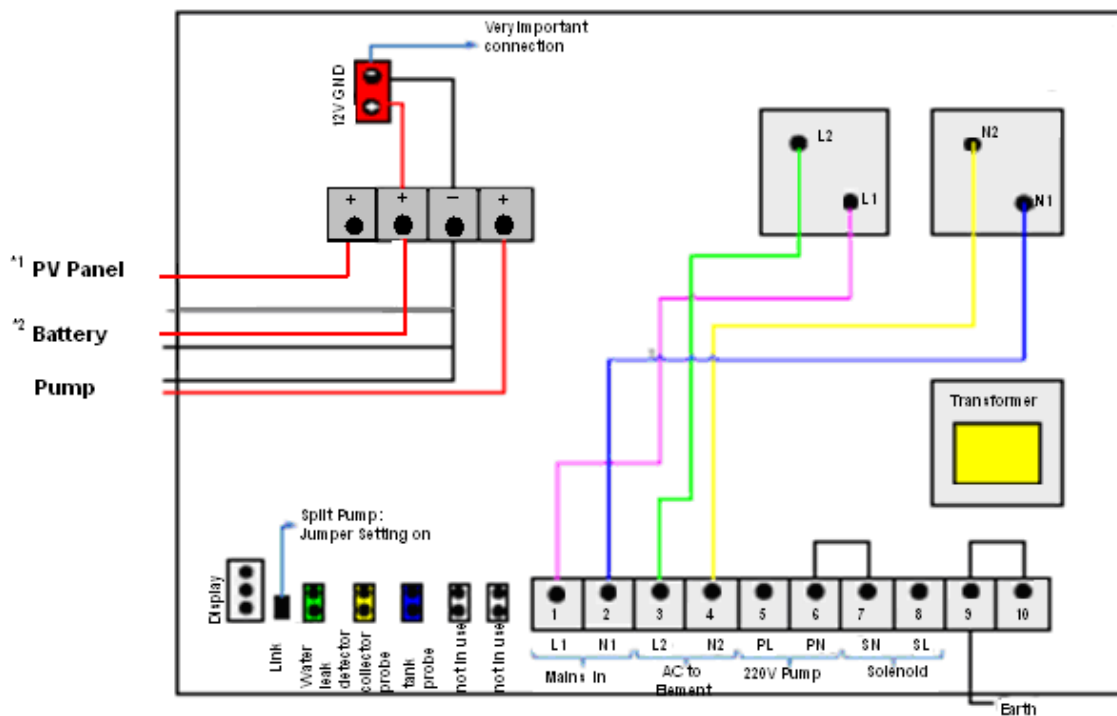

Notes

¹ - PV Panel 5 - 10 WATT Recommended
 PV Panels are a serviceable item and must be kept free from dust and dirt

² - Battery 4 AH 12 Volt
 Life expectancy 3-5 years serviceable

5.3 Terminal Plan and Wiring Diagram

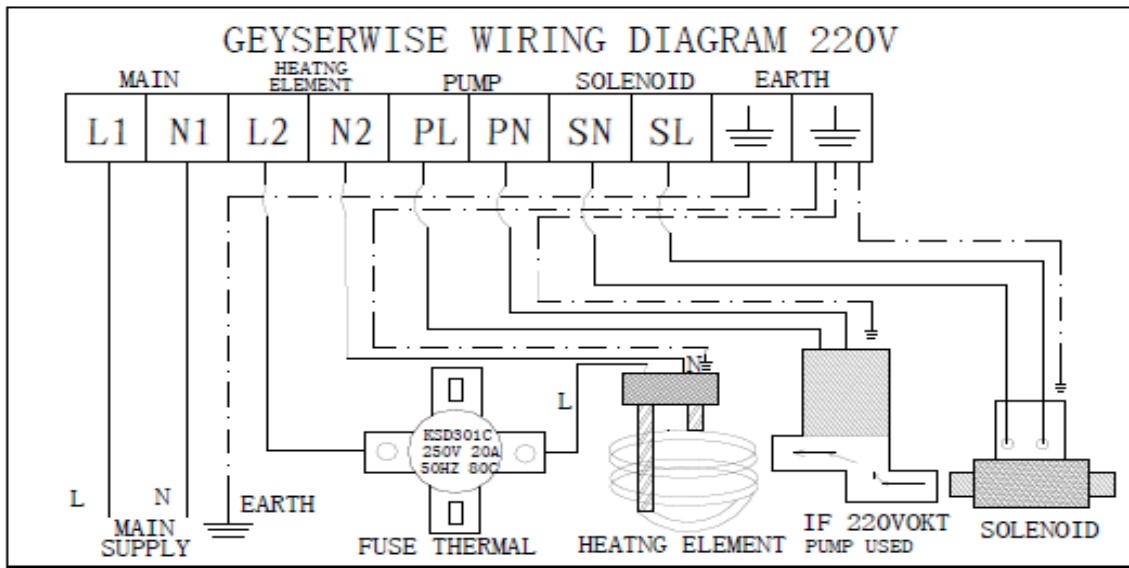

5.4 Connector Plan

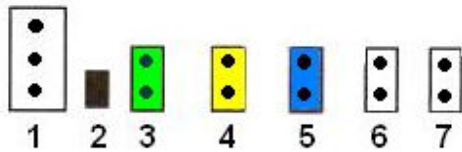

- 1 = Display
- 2 = Status Jumper
- 3 = Water leak detector
- 4 = Collector Probe
- 5 = Tank probe
- 6 = RF Connector
- 7 = Anode Depletion

5.5 12V Battery Plan

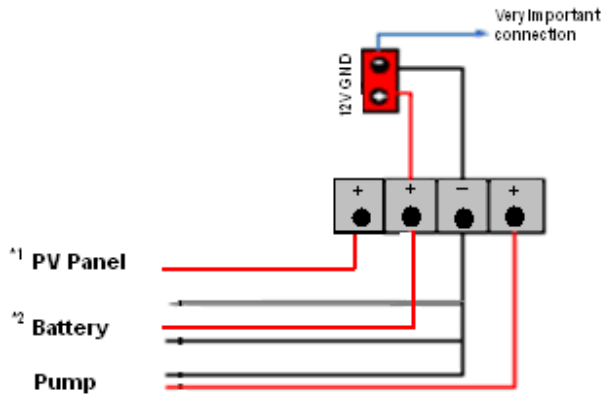

It is recommended that a 4 AH 12 V battery together with a 10 Watt PV panel is used

5.6 Installation: Geyser and Thermosiphon Solar System

*For geyser and Thermosiphon solar application, remove the status jumper [Diagram 5.4]. Please follow the terminal plan as per Diagram 5.3 and connector plan as per Diagram 5.4

- Remove thermostat. Push temperature probe with thermal fuse into thermostat pocket. Connect temperature probe to connector 5 (Diagram 5.4)
- Connect live and neutral main incoming supply to L1 and N1 respectively and EARTH to either of the two terminals provided for the earth (Diagram Chapter 5.3)
- Connect L2 to Thermal cut out in and from thermal cut out to the heating element. Connect N2 directly to the heating element (Diagram Chapter 5.3).
- Connect live and neutral solenoid shutoff (WHEN INSTALLED) to SN and SL respectively. Connect EARTH to either of the two terminals provided for the earth (Diagram Chapter 5.3)
- Connect all earth wires to earth terminals. Ensure all parts are properly earthed.
- Connect Water Leak Detector into green connector 3 (Diagram 5.4). Place water leak detector in drip tray or other suitable place.
- Plug anode indicator (Optional) into connector 7 (Diagram 5.4), one end to reference probe (red wire) and the other end (black wire) to the earth of the tank.
- If the anode indicator is not required, switch slide at the back of the display unit to the off position after which the Anode light will be off.

5.7 Installation: Split pump system with 220V Pump

Follow all the instructions as for the installation as per Chapter 5.3 and the following additional steps:

- Insert collector probe into appropriate place on the collector to measure temperature. Connect collector probe to connector 4 (Diagram 5.4)
- Connect 220 volt AC circulation pump live and neutral to terminals PL and PN (diagram chapter 5.2). Connect the earth to either terminals provided for the earth

5.8 Installation: Split pump system with 12V pump, PV panel and back-up battery

Follow all the instructions as for the installation as per Chapter 5.5 and the following additional steps:

- Insert collector probe into appropriate place on the collector to measure temperature. Connect collector probe to connector 4 (Diagram 5.4)
- Connect PV panel and battery as indicated in diagram 5.5
- Connect 12v pump as indicate in diagram 5.5
- Connect 12v power as indicated in diagram 5.5

6 OPERATION: HOT WATER CYLINDER ONLY (NO SOLAR INSTALLED)

6.1 Display

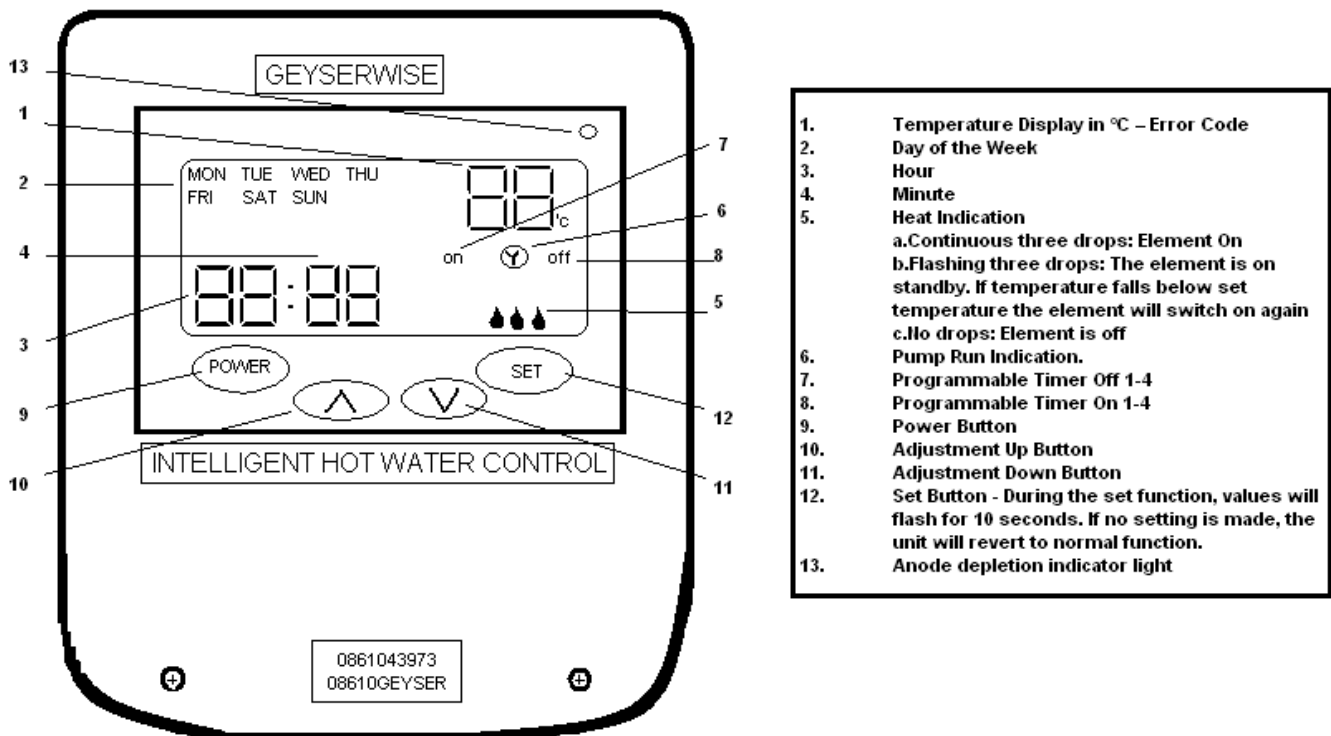

1. Temperature Display in °C – Error Code
2. Day of the Week
3. Hour
4. Minute
5. Heat Indication
 - a. Continuous three drops: Element On
 - b. Flashing three drops: The element is on standby. If temperature falls below set temperature the element will switch on again
 - c. No drops: Element is off
6. Pump Run Indication.
7. Programmable Timer Off 1-4
8. Programmable Timer On 1-4
9. Power Button
10. Adjustment Up Button
11. Adjustment Down Button
12. Set Button - During the set function, values will flash for 10 seconds. If no setting is made, the unit will revert to normal function.
13. Anode depletion indicator light

6.2 Setting the water temperature

Important notice: The temperature setting is the temperature setting for the electric element. If a solar geyser is installed, the sun may heat the water beyond the temperature set on the unit.

The water temperature is set to a factory default of 55°C.

The temperature can be set in four different time slots:

Temperature setting 1 applies to the time slot 00h00 to 05h59

Temperature setting 2 applies to the time slot 06h00 to 11h59

Temperature setting 3 applies to the time slot 12h00 to 17h59
Temperature setting 4 applies to the time slot 18h00 to 23h59

If changes to the water temperature are required please follow the steps below

Temperature setting 1

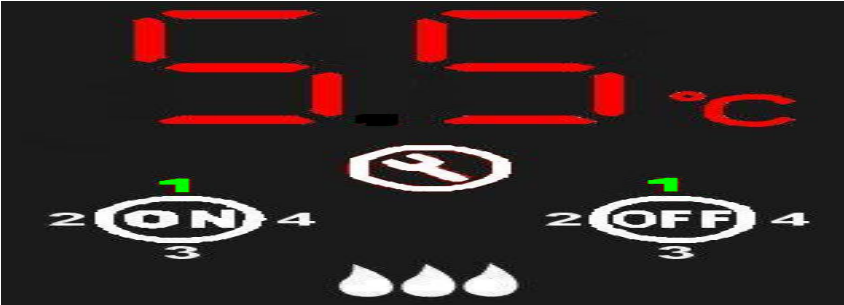

Press **SET** and release. The first temperature setting will flash in red on the screen together with the number 1 (in green) on the programmable timer settings on and off. Use the **^** and **v** buttons to adjust the temperature.

Temperature setting 2



Press **SET** immediately after setting temperature setting 1 and release to move to the second temperature setting. The second temperature setting will flash in red on the screen together with the number 2 (in green) on the programmable timer settings on and off. Use the **^** and **v** buttons to adjust the temperature.

Temperature setting 3

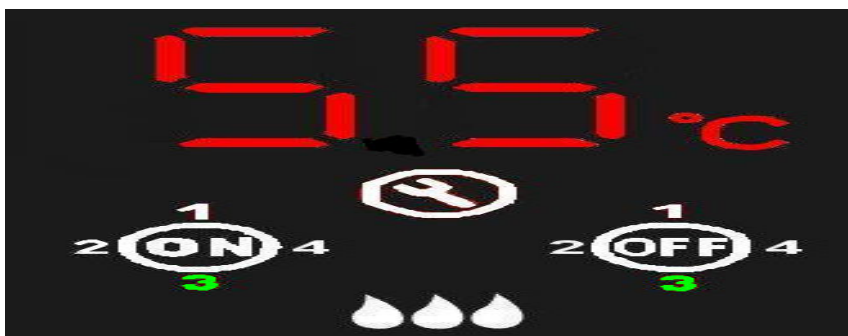

Press **SET** immediately after setting temperature setting 2 and release to move to the third temperature setting. The third temperature setting will flash in red on the screen together with the number 3 (in green) on the programmable timer settings on and off. Use the **^** and **v** buttons to adjust the temperature.

Temperature setting 4





Press **SET** immediately after setting temperature setting 3 and release to move to the fourth temperature setting. The fourth temperature setting will flash in red on the screen together with the number 4 (in green) on the programmable timer settings on and off.

off. Use the  and  buttons to adjust the temperature.





6.3 Adjusting the day of the week

Press the  button 5 times (or once immediately after setting temperature 4 above) and release.

The day of the week will flash in green on the screen. Use  and  buttons to adjust the day of the week.

6.4 Adjusting the time

Press the  button 6 times (or once immediately after setting the day of the week) and release.

The hours will flash on the screen. Use  and  buttons to adjust the hour. Press  again and release. The minutes will flash on the device. Use  and  buttons to adjust the minutes.

6.5 Setting the timers

By factory default, the programmable timer is set as follows for Monday to Friday:

Timer 1 : 03h00 **ON** – 06h00 **OFF**

Timer 2 : 16h00 **ON** – 18h00 **OFF**

Timer 3 : --:-- **ON** – --:-- **OFF**





Timer 4 : --:-- **ON** – --:-- **OFF**

TO SET THE TIMER ON AND OFF FOR MONDAY TO FRIDAY, FOLLOW THE STEPS BELOW

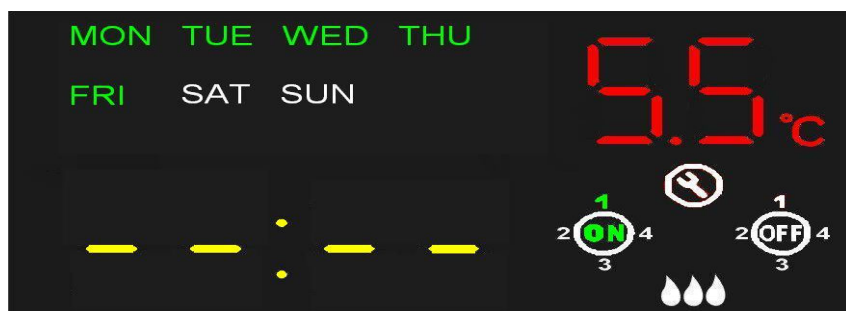
TIMER 1 ON

Press  8 times, the Timer 1 on the 'timer on' indicator and the Mon-Fri display flash simultaneously in green. The hours will flash in yellow.







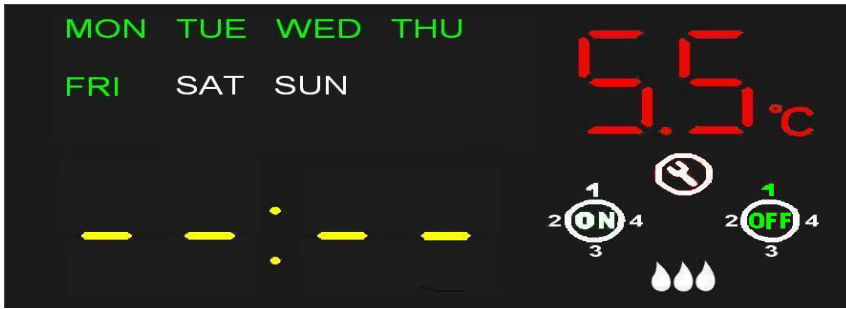

Use the  and  buttons to adjust the hours. Press  immediately after setting the hours and the minutes will flash in yellow. Use the  and  buttons to adjust the minutes.

TIMER 1 OFF

Press the  button immediately after setting 'Timer 1 On', the Timer 1 on the 'timer off' indicator and the Mon-Fri display will flash simultaneously in green. The hours will flash in yellow.







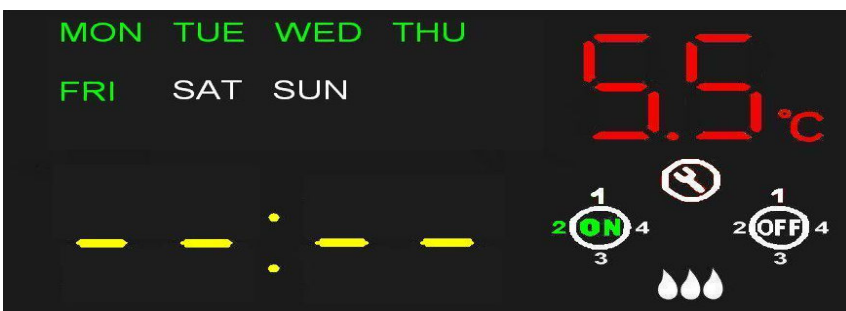

Use  and  buttons to adjust the hours. Press  immediately after setting the hours and the minutes will flash in yellow. Use the  and  buttons to adjust the minutes.

To immediately proceed setting the times for Timer 2 on/off after setting timer 1, press the  button.

TIMER 2 ON

The timer 2 on the 'timer on' indicator and the Mon-Fri display flash simultaneously in green. The hours will flash in yellow.







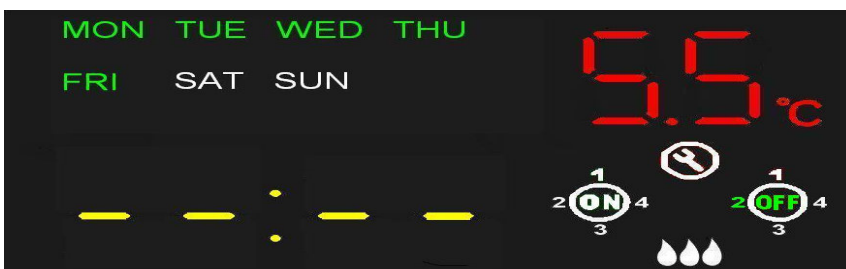

Use  and  buttons to adjust the hours. Press  immediately after setting the hours and the minutes will flash in yellow. Use  and  buttons to adjust the minutes.

TIMER 2 OFF

Press the  button immediately after setting 'Timer 2 On', the Timer 2 on the 'timer off' indicator and the Mon-Fri display will flash simultaneously in green. The hours will flash in yellow.



Use  and  buttons to adjust the hours. Press  immediately after setting the hours and the minutes will flash in yellow. Use  and  buttons to adjust the minutes.

To immediately proceed setting the times for Timer 3 on/off after setting timer 2, press the  button.

TIMER 3 ON

Follow the same steps as for Timer 1&2 ON as per above explanation.

TIMER 3 OFF

Follow the same steps as for Timer 1&2 OFF as per above explanation.

To immediately proceed setting the times for Timer 4 on/off after setting timer 3, press the **SET** button.

TIMER 4 ON

Follow the same steps as for Timer 1&2&3 ON as per above explanation.

TIMER 4 OFF

Follow the same steps as for Timer 1&2&3 OFF as per above explanation.

PLEASE NOTE THAT YOU DO NOT HAVE TO MAKE USE OF ALL FOUR TIMER SETTINGS. TO ELIMINATE A TIMER SETTING, PLEASE SET TIME TO - :- - ON AND - :- - OFF

To immediately proceed setting the times for Saturday and Sunday on/off after setting timer 4, press the **SET** button.

TO SET THE TIMER ON AND OFF FOR SATURDAY TO SUNDAY, FOLLOW THE STEPS BELOW

TIMER 1 ON/OFF

Press the **SET** button 24 times, the Timer 1 on the 'timer on' indicator and the Sat-Sun display flash on the screen simultaneously. Proceed setting times for Timer 1&2&3&4 as per the instructions as per Monday to Friday instructions.

If at any stage you would like to reset the timers back to the factory defaults, press **POWER** and hold the button for six seconds. On release, the timers will be reset to the factory default.

6.6 Power save mode

To set the device to Power Save Mode, press and hold the **SET** button for six seconds. Only the temperature display will be on.

To reset from Power Save Mode, press any button. The full display will come on.

6.7 Switching the unit on Holiday Mode

To switch the unit off, press and hold the **POWER** and the **SET** buttons simultaneously. The words OFF will be displayed in Programmable Timer Off .

To switch the unit back on, repeat the above steps.

6.8 Bypassing the Timer





To bypass the timer settings and to heat water immediately, press and



release the **POWER** button. Three water droplets will illuminate on the display. Three solid drops indicate that the element is on and water is being heated with electricity.

When the droplets 'flash', power is on, but the water has already been heated to the set temperature so the element is on stand-by. When the temperature drops by 7 degrees

below the set temperature, the element will switch back on.

6.9 Check the energy usage in hours.

Press the  and  buttons simultaneously for 3 seconds and release. The number of hours of electricity used by the element (up to a maximum of 99 hours) will be on the display.

To reset to the hours of electricity used to ZERO, press and hold  and  buttons for 6 seconds

To revert back to normal display press the  and  buttons simultaneously for 3 seconds

6.10 Useful tips to achieve energy savings with the Geyserwise (no solar installed)



It is important to remember that all households have different requirements for hot water during a 24 hour day. Below are some general tips on how to achieve maximum savings by using the Geyserwise as an energy management tool:

- Eskom recommends lowering the thermostat on the geyser to between 50 and 60 degrees Celcius. Lowering the temperature from 65 degrees to 55 degrees could save 21% on energy needed to heat hot water.
- Only heat water when it is needed. If hot water is only used during the mornings and evenings, set your geyser to only heat the water for these times. It only takes approximately 1 hour to heat water from 30 degrees to 55 degrees for 150 L of water and 3 Kwh element
- Try and switch the geyser off at a low temperature (below 30 degrees). This will reduce the standing losses (water cooling down) of the water. On warm summer days, temperature can be gained during the day if the geyser is switched off at a low temperature in the mornings.

7 OPERATION: Thermosiphon (Passive) Solar

- The temperature of the geyser will be displayed at all times
- Timers can be set for times of the day when Solar is not effective (night time)
- The user can choose not to set any timers if hot water generated by the solar system is sufficient for all daily hot water needs. Set timers to - -: - - on and - - : - - off to disable timers
- If at any time hot water is needed simply press the **POWER** button. Three water droplets will illuminate on the display to indicate that the element is on. The water will be heated to 55°C unless set otherwise.

8 OPERATION: Pump (Active) Solar

- The temperature of the geyser will be displayed at all times
- Timers can be set for times of the day when Solar is not effective (night time)
- The user can choose not to set any timers if hot water generated by the solar system is sufficient for all daily hot water needs. Set timers to - - : - on and - - : - -off to disable timers
- If at any time hot water is needed simply press the **POWER** button. Three water droplets will illuminate on the display to indicate that the element is on. The water will be heated to 55°C unless set
- To display the collector temperature Press  and  together and release. The collector temperature will display. To reset to usual setting, repeat the action.
- The pump to circulate the water through the system is controlled by the Geysewise Max. As soon as the collector temperature is 7°C higher than the geyser, the pump will switch on to circulate the hot water in the collector through to the geyser. As soon as the differential between the collector and the geyser falls below 2°C, the pump will automatically be switched off. The pump indication symbol will display as soon as the pump is switched on.

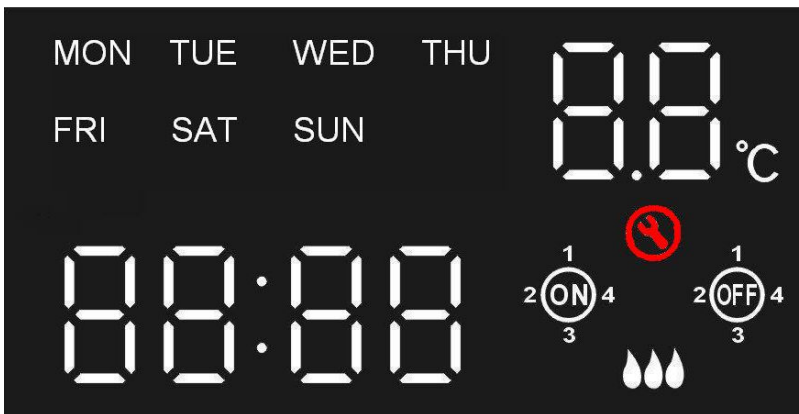

As soon as the collector temperature is 7°C higher than the geyser, the pump will switch on to circulate the hot water in the collector through to the geyser. As soon as the differential between the collector and the geyser falls below 2°C, the pump will automatically be switched off. The pump indication symbol will display as soon as the pump is switched on.

- The pump has a minimum run time of one minute and a maximum run time of 30 minutes.
- When in off/holiday mode the tank temperature will be checked at 18h00 daily. If the tank is over 50 degrees C the system will circulate water through collector to cool down to 50 °C in order to avoid temperature build up whilst no water is withdrawn.
- Anti freeze protection: when the collector reaches 5 degrees the pump will circulate hot water from the tank for 2 minutes at a time.
- Pump and TP valve protection: when the tank reaches 80 degrees C the pump will stop circulating.

9 ERROR CODES

9.1 Summary of error Codes

ERROR CODE	EXPLANATION	POSSIBLE CAUSE
E1	Earth leakage	Faulty element/Electric circuit
E2	Dry burn protection	Cylinder empty
E3	Sensor failure (water tank)	Faulty sensor/Open circuit
E4	Heat failure	Element failure
	Error only applied whilst heating element ON.	Leaking hot water pipe
		Faulty valve
		Scale build-up
		No power supply to element Solar Thermo siphon
E5	Over temperature protection	Geyser temp exceed 85° C
		System shut down Auto reset.
E6	Water leak	Leaking tank
		Valves
		Overflow
E7	Communications failure	Check comms wire between control and display
E8	Probe failure (collector)	Faulty sensor
E9	Pump failure	Check pump connections

9.2 E1

The Geyserwise system has onboard earth leakage protection. This forms a very important part of the installation. Should any leakage current occur within the geyser circuit, this will be highlighted by means of an E1 Error Code and will shut the system down.

Possible causes and remedies for E1 (earth leakage)

- Heating element pinned or holed: Switch off power at the main power supply. Test the heating element to establish any continuation to the earth path. If any continuation in the earth path is present, replace the element.
- Current leakage from the distribution board: Switch off relevant circuits and test the circuit to establish origin of leakage.
- 220 V pump earth leakage. Check pump for possible earth leakage
- Damp in electrical components if tank situated outside: Check that no damp is penetrating the electrical components. Improve ingress protection.
- General: Check that all connections are tight and secure. A loose neutral wire can also cause earth leakage.

Contact a qualified electrician to perform above checks.

9.3 E2: Dry burn protection

In case of an E2 error the Geyserwise will shut down the power supply to the heating element.

Possible causes and remedies:

- Empty geyser as a result of burst water mains

9.4 E3: Tank temperature probe (-20 °C to 130 °C)

In case of an E3 error code the element will be shut down

Possible Causes:

- Check cable connection plugged into blue connector plug
- Check if probe wire intact
- Faulty sensor: check resistance according to table in Chapter 10

9.5 E4: Heat loss or diminished rate of heating water

- Element failure: Element not heating water at all when switched on.
 - Check tank temperature and element resistance. Replace element if no resistance
 - Check connections of element intact.
- Check thermal cutout continuity: If tank goes over temperature (85 degrees) the thermal fuse will cut-out and no power to heating element. Reset thermal cut-out by pressing red button at top.
- Leak in hot water system: Close all taps and check water meter.
- Solar: Heat loss to panel. Check panel temperature in evening. The panel should cool down to ambient temperature in the evening. If panel the temperature is much higher than ambient in the evening check heat traps and non-return valves to prevent reverse thermo siphoning.

9.6 E5: Tank over 85 degrees celcius

E5 will display if the geyser temperature exceeds 85 degrees when heated electrically (not with solar). This will shut the system down. Switch off power at mains and check for possible cause.

Ensure no connections are bridged. Check relays in the power supply not melted (unlikely), live and neutral are operated independently and no continuation to heating element

If heated by means of solar, E5 will auto reset when water withdrawn and the tank is cooled down. Check panels are appropriate for size tank used to prevent over-design of system.

9.7 E6 – Water leak detection

Check drip tray for presence of water. Possible causes;

Leaking valves
Leaking pipes
Leaking tank

9.8 E7 – Communications error

This will keep the system running normally in event of solar pumped system with the exception that the heating element will not be switched on at any time.

Possible cause:

- Check linking cable between power supply box and remote display
- Recommended cabling not to exceed 20m. Also check connections if extended.

9.9 E8 - Collector temperature probe (-40 °C to 260 °C)

- Probe failure: Check resistance
- Check connection cable intact
- Collector over temperature (above 120 degrees).
- Tank temperature over 80, flash E8 and tank temperature respectively.

In the event of a failure the pump will run continuously until panel has cooled down or the error corrected (indicated by red spanner).

If tank temperature over 80 degrees, the pump will not run, to prevent the tank temperature climbing further. Check overdesign of the system.

9.10 E9 – Pump/Circulation

This error will occur when the differential between the tank and collector keeps increasing till collector temperature reaches 99 degrees c. The pump will continue running at 30 minute on/30 sec off intervals.

If temperature in collector continues rising, this will change status to E8.

Check circulation: No blockages in pipes, faulty valves, faulty pump. Check power supply to pump

10 Sensor R-T Table

SENSING(R-T TABLE)

T(jæ)	R(k!)
-30	187.6
-20	101.7
-10	57.77
0	33.42
10	20.44
20	12.61
30	8.017
40	5.268
50	3.556
60	2.386
70	1.674
80	1.221
90	0.9491
100	0.7635
110	0.5723
120	0.4286
130	0.3314
140	0.265
150	0.2166
160	0.1828
170	0.1502
180	0.1205
190	0.08939
200	0.06634

R25jæ=10.0k!,
B25/50=3850K

11 Warranty

7cc`ei]d`!`7c`X`: UWh ("the supplier") warrants to the original purchaser of this product ("the customer") that this product will be free of any defects in material and workmanship which under normal, personal, family or household purpose manifest themselves within a period of 365 days from the date of purchase or in respect of commercial or professional purposes, manifest themselves within a period of 90 days from the date of purchase. Any claim in terms of the warranty must be supported by proof of purchase. If such proof of purchase is not available, then notwithstanding anything to the contrary herein, the supplier's normal charge of service and/or spares will be payable by the customer upon collection of the repaired product. If a claim is made in terms of the aforesaid warranty within the first 7 days from date of purchase, the faulty product will be exchanged (provided that the product is in its original packaging with all accessories). Failing return of the product within 7 days, the supplier's liability shall be limited on return to the supplier of the products or parts thereof, to the replacement or repair (in the sole discretion of the supplier, or its duly authorised dealer) of the product to eliminate any defect in the workmanship or materials found to be due exclusively to any acts or omissions on the parts of the supplier, of which any defects the supplier shall have been notified in writing by the customer within aforesaid warranty period. The warranty provided herein and the obligations of the supplier as aforesaid are in lieu of, and the customer waives, all other warranties, guarantees, conditions or liabilities, express or implied, arising by law or otherwise, including without limitation, any obligation of the supplier in respect of any injury, loss or damage (direct, indirect or consequential) arising out of the use of, or inability to use, this product and whether or not occasioned by the suppliers' negligence (gross or otherwise) or any act or omission on its part. The warranty excludes any abuse or any non-authorised modification of this product. During the warranty period the product should be taken to a service centre of the supplier or one of its duly authorized service agents. The supplier neither assumes nor authorizes service agents. The supplier neither assumes nor authorizes any other person to assume for it, any additional liability in connection with the sale or servicing of its products.

12 Company Details

Ccc`ei]d`!`7c`X`: UWh

Tel. 01%0`69`7CC@f&3`&* *) Ł

9`a UJ. `]bZc4 Vtc`ei]d`Vtc`nU`

www.Vtc`ei]d.co.za